

LUCAS

“MAGDYNO”

(TYPES MDB, MDBR)

(LIGHTING AND IGNITION)

FOR

MOTOR-CYCLES

SPARE PARTS

1929 EQUIPMENT

C. DEAN, M/Cyclon
The Lodge Garage,
2, LEYLAND ROAD
PENWORTHAM,
PRESTON.



NOVEMBER, 1928.

LUCAS "MAGDYNO" (1929) EQUIPMENT

HEADLAMP TYPE SS49.

POSTAGE.	PART NO.	DESCRIPTION OF PART.	PRICE.		
			£	s.	d.
6d.	L700	Lamp Body	14	6	each
4d.	L701	Reflector, complete with Bulb Holder Interiors	10	6	each
6d.	L308	Front Rim, complete with "Difusa" Glass	5	0	each
4d.	L311	Glass only, "Difusa"	2	6	each
2d.	L313	Rubber Cord for fixing glass		4	each
2d.	8S	Bulb for tail, side and pilot light	1	6	each
2d.	2S	Bulb for high light	2	9	each
2d.	L702	Bulb Holder Interior	1	0	each
2d.	L703	Side Socket Screw		6	each
2d.	L704	Washer for side socket screw		6	doz.
2d.	L322	Cotter Pin for reflector coil spring		3	doz.
2d.	L226	Washer for reflector coil spring		3	doz.
2d.	L321	Reflector Coil Spring	1	6	doz.
6d.	L705	Girder Bracket, complete for SS49 lamp	4	6	pair
2d.	L706	Earpiece Clip for brackets type 48, F39, 85		3	each
2d.	L707	Bracket Nut with Spring Washer for large eyebolt	2	0	doz.
2d.	L708	Bracket Arm only		6	each
2d.	L709	Large Eyebolt		4	each
2d.	L710	Metal Washer for large eyebolt	1	0	doz.
2d.	L711	Clip Liners		3	pair
2d.	L712	Clip Nut with Bolt		6	each
3d.	L713	Handle Bar Clip, complete	1	6	pair
6d.	L714	Bracket, type F39, complete (front fork fitting)	3	6	pair
3d.	L715	Bracket Arm with clip	1	0	each
2d.	L716	Handle Bar Clip only		6	pair
2d.	L717	Bolt for clip		4	each
2d.	L718	Nut for bolt	2	0	doz.
6d.	L719	Bracket, type 68J, complete, 11½ in. long	4	6	pair
2d.	L720	Bush for brackets 68J and 68N	2	0	doz.
2d.	L721	Collar for brackets 68J and 68N	3	0	doz.
2d.	L722	Washer for brackets 68J		9	doz.
6d.	L723	Bracket, type 68N, complete, 11½ in. long	4	6	pair
6d.	L724	Bracket, type 68S, complete, 10½ in. long	4	6	pair
3d.	L725	Bracket Arm only	2	1	each
6d.	L726	Bracket, type 68, complete, 11¾ in. long	4	6	pair
2d.	L727	Nut for brackets 68, 68N, 68J, 68S, and 85	2	0	doz.
6d.	L728	Bracket, type 85, complete	4	6	pair
3d.	L729	Bracket Arm only	2	1	each

SIDE CAR LAMP TYPE R330S.

			£	s.	d.
4d.	L420	Body	5	9	each
3d.	L435	Reflector, complete with Bulb Holder Interior	2	6	each
2d.	L424	Front Rim with Plain Glass	2	6	each
2d.	L426	Plain Glass only	3	0	doz.
2d.	L428	Rubber Ring for fixing glass	2	0	doz.
2d.	L325	Bulb Holder Interior (single pole)	1	0	each
2d.	L433	Washer for reflector coil spring		3	doz.
2d.	L434	Cotter Pin for reflector coil spring		3	doz.
2d.	L432	Reflector Coil Spring	1	0	doz.
2d.	L430	Nut for spigot		6	doz.
2d.	L431	Spring Washer for spigot	2	0	doz.
2d.	L429	Spigot Base		4	each

L700

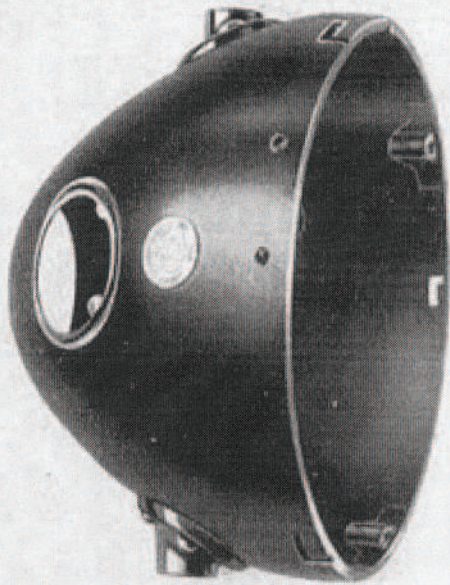

L701

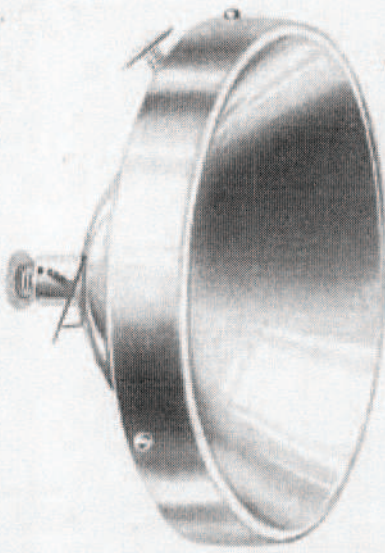

L308

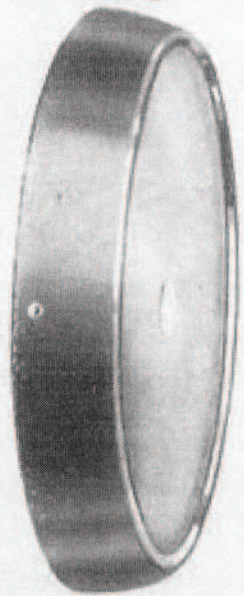

L703



L704



L322



L226



L321



L702

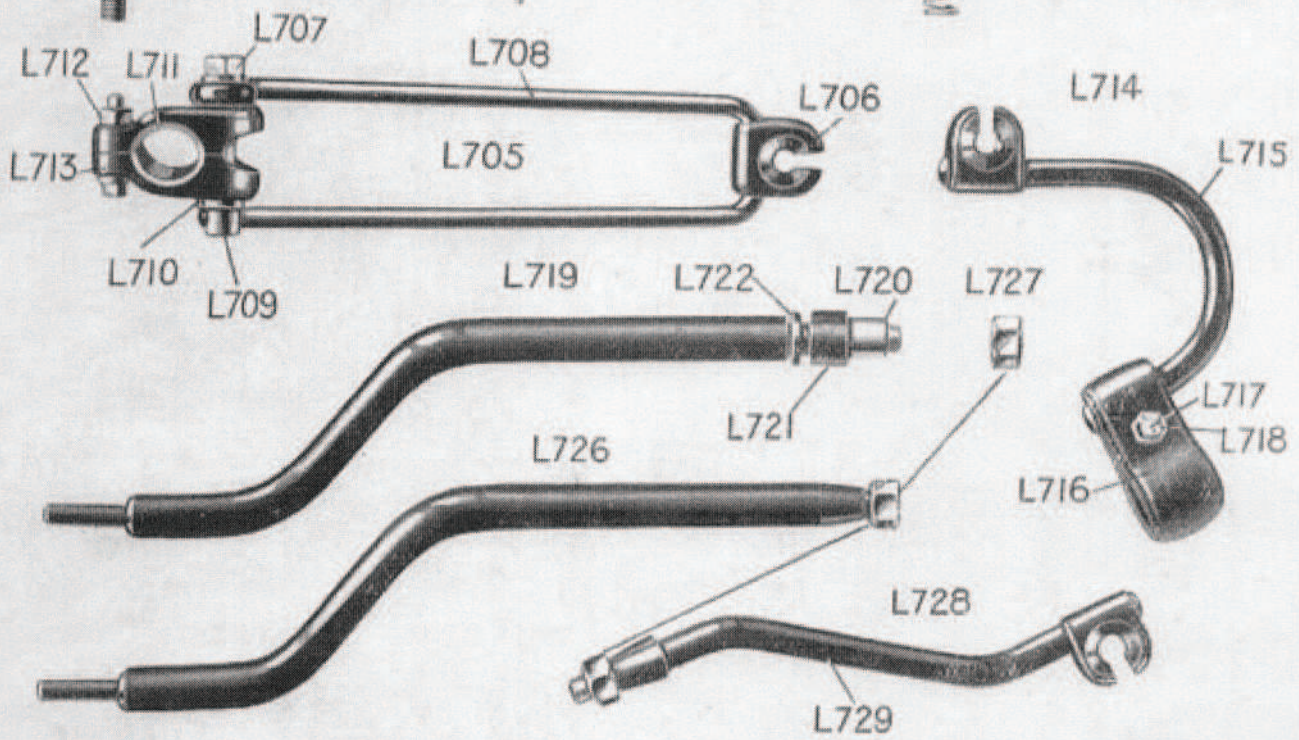

L433



L434



L432



L430



L431



L429



L420

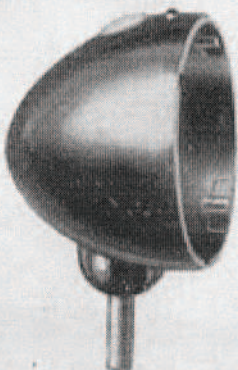

L435

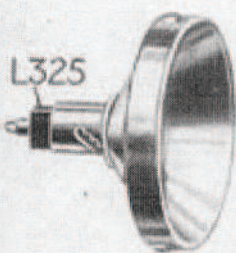

L424

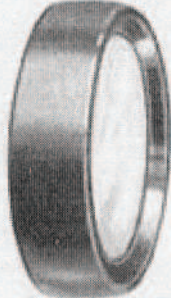

L750



L751



L752

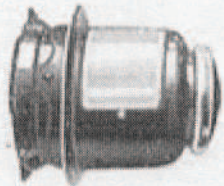

TAIL LAMP TYPE MT110.

POSTAGE.	PART NO.	DESCRIPTION OF PART.	PRICE.
			£ s. d.
2d.	L750	Cable Bush	3 0 doz.
3d.	L751	Back Half, less bulb	4 3 each
3d.	L752	Front Half, complete	3 0 each

RS39 SWITCH PARTS AS FITTED ON SS49 HEADLAMPS.

2d.	S460	Switch Knob	9 each
2d.	S461	Fixing Screw for switch knob	2 0 doz.
2d.	S462	Fixing Screw for resistance bobbin	1 6 doz.
2d.	S463	Resistance Bobbin	6 each
2d.	S464	Wire Coil for resistance bobbin	6 each
2d.	S465	Lock Washer for fixing screw S462	6 doz.
2d.	S466	Insulating Washer for fixing screw S462	6 doz.
2d.	S467	Resistance Connector Assembly	9 each
2d.	S468	Securing Plate for resistance	1 0 doz.
3d.	S469	Resistance, complete	2 0 each
3d.	S470	Switch Body, complete with Terminal Posts	5 0 each
2d.	S471	Grub Screw for terminals	6 doz.
3d.	S472	Switch Assembly, complete	10 6 each
2d.	S473	Lever Spring for switch contact	1 0 doz.
2d.	S474	Washer for contact lever stud	6 doz.
2d.	S475	Cotter Pin for contact lever stud	3 doz.
2d.	S476	Shaft, complete with Head-piece	9 each
2d.	S477	Milled Nut for resistance fixing bar and switch strap	1 6 doz.
2d.	S478	Bush for switch lever	3 doz.
2d.	S479	Spring for head-piece	1 0 doz.
2d.	S480	Switch Contact Lever (left hand)	3 0 doz.
2d.	S481	Switch Contact Lever (right hand)	3 0 doz.
2d.	S482	Plunger Roller for head-piece	1 0 doz.
2d.	S483	Plunger for head-piece	1 0 doz.
2d.	S484	Fixing Strap for switch	4 each
2d.	S485	Resistance Fixing Bar	3 0 doz.
3d.	S486	Ammeter, CZ2 (illuminated type)	7 6 each
2d.	S487	Insulating Plate for ammeter	2 0 doz.
2d.	S488	Spring Washer for ammeter	6 doz.
2d.	S489	Fixing Band for ammeter	9 each
2d.	S490	Long Fixing Screw for band	1 0 doz.
2d.	S491	Short Fixing Screw for band	9 doz.
2d.	S492	Nut for fixing screw S491	1 0 doz.
2d.	S493	Nut for securing ammeter	1 0 doz.
2d.	S494	Nut for fixing ammeter connection	1 0 doz.
2d.	S495	Insulating Piece for ammeter terminals	2 0 doz.

BATTERY LUW7E.

	739	Battery, complete—dry	1 0 0 each
6d.	616	Milam Cover for battery	3 6 each
2d.	618	Lead, complete with Terminal Lug and Brass Cable Adaptor	1 3 each
2d.	619	Terminal Lug only	3 0 doz.
2d.	733	Lead, complete with Terminal Lug—negative	1 3 each
2d.	728	Cable Connector, complete	4 6 doz.
2d.	729	Rubber Shield for connector	1 0 doz.
2d.	730	Cable Connector	2 6 doz.
2d.	731	Washer for cable connector	3 doz.
2d.	732	Nut for cable connector	2 6 doz.
2d.	597	Vent Plug	4 each
2d.	598	Rubber Washer for vent plug	6 doz.

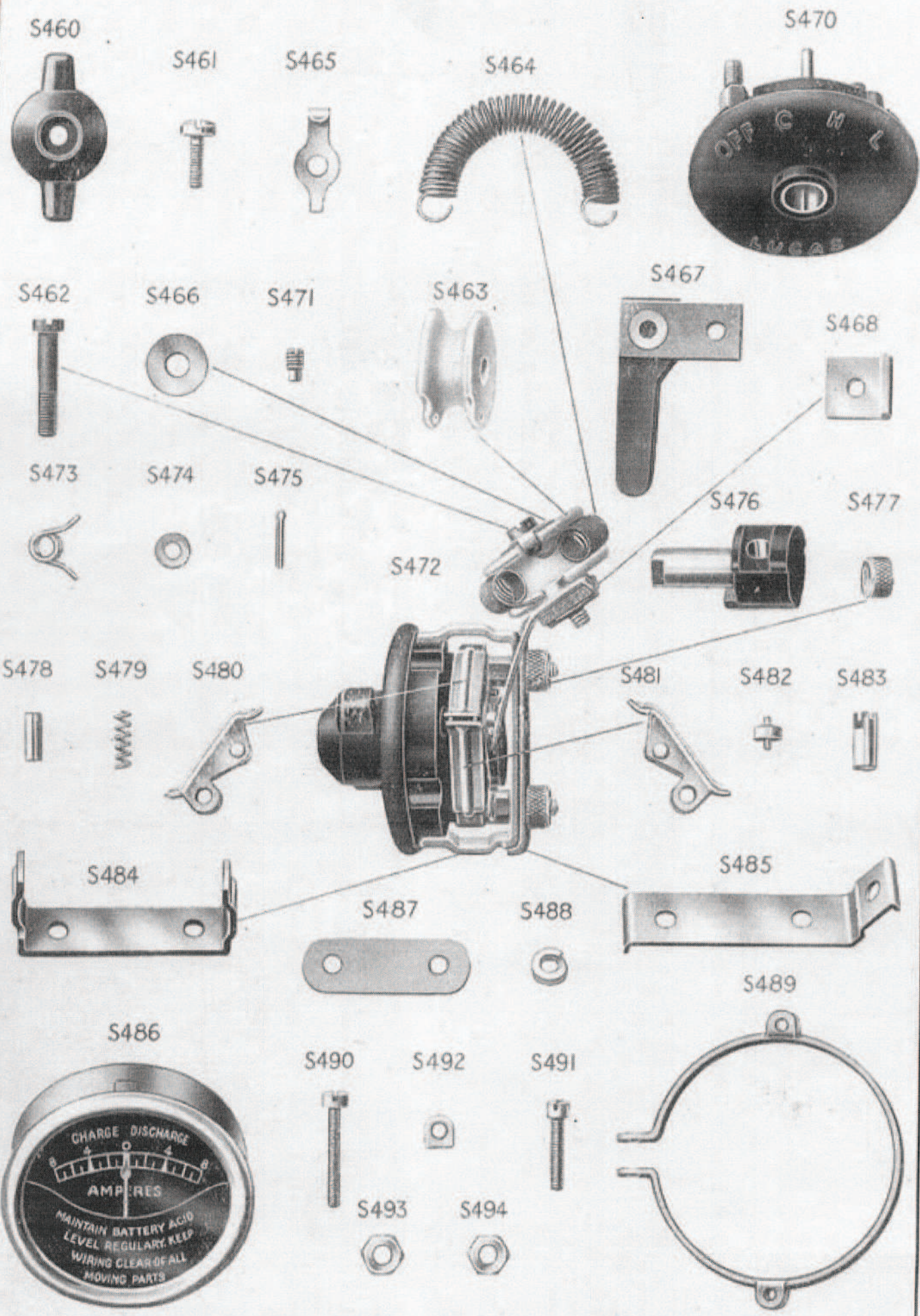

S460

S470

S461

S465

S464

S462

S466

S471

S463

S467

S468

S473

S474

S475

S472

S476

S477

S478

S479

S480

S481

S482

S483

S484

S485

S486

S487

S488

S489

S490

S492

S491

CHARGE DISCHARGE

AMPERES

MAINTAIN BATTERY ACID
LEVEL REGULARLY. KEEP
WIRING CLEAR OF ALL
MOVING PARTS

S493

S494

BATTERY LUW7E—Continued.

POSTAGE.	PART NO.	DESCRIPTION OF PART.	PRICE.		
			£	s.	d.
4d.	617	Connector	2	0	doz.
2d.	620	2-Volt Cell Lid		5	each
2d.	624	Locking Ring	1	0	doz.
2d.	625	Rubber Washer for locking ring		6	doz.
6d.	742	Plates—2-volt sections—positive	1	9	each
6d.	743	Plates—2-volt sections—negative	2	3	each
2d.	623	Separator	2	0	doz.
6d.	740	Milam Case for battery	4	6	each
6d.	746	Battery Carrier, complete (solo or sidecar)	5	0	each
6d.	747	Battery Carrier, less loose plate	3	0	each
2d.	745	Carrier Strap	3	0	doz.
2d.	586	Knurled Nut for carrier strap	3	0	doz.
6d.	748	Loose Plate, complete, for battery carrier	2	0	each
2d.	749	Clip for fixing carrier		4	pair
2d.	750	Nut for bolt 751	2	0	doz.
3d.	751	Bolt for clip	2	0	doz.
2d.	752	Carrier Strap	3	0	doz.

“MAGDYNO”—Dynamo Portion.

6d.	790	Commutator End Bracket, complete with Brushes, Cut-out, etc. (anti)	1	1	6 each
6d.	789	Commutator End Bracket, complete with Brushes, Cut-out, etc. (clockwise)	1	1	6 each
6d.	690	Cut-out	6	6	each
2d.	697	Coil Spring for cut-out	2	0	doz.
2d.	770	Terminal Insulating Shield	3	0	doz.
2d.	771	Terminal		6	each
2d.	693	Fixing Screw for terminal	1	0	doz.
2d.	772	Spring Washer for fixing screw		6	doz.
2d.	654	Grub Screw for terminal		9	doz.
2d.	773	Insulating Piece		6	each
2d.	774	Fixing Screw for insulating piece		9	doz.
2d.	655	Terminal Nut	3	0	doz.
2d.	775	Connector		9	doz.
2d.	658	Brush Lever (left hand)	2	0	doz.
2d.	659	Brush Lever (right hand)	2	0	doz.
2d.	660	Brush Spring (left hand)	3	0	doz.
2d.	661	Brush Spring (right hand)	3	0	doz.
2d.	776	Terminal Pin (earthed)		6	each
2d.	778	Terminal Pin (insulated)		6	each
2d.	164	Spring Washer for terminal pin		6	doz.
2d.	419	Plain Washer for terminal pin		3	doz.
2d.	791	Spring Pin (control)	2	0	doz.
2d.	792	Spring Washer for spring pin		6	doz.
2d.	793	Bush for spring pin	2	0	doz.
2d.	794	Spring (control)	3	0	doz.
2d.	795	Spring Lever (control)	2	0	doz.
2d.	656	Brush (main and control)	2	0	each
2d.	662	Cotter Pin for brushes		3	doz.
2d.	663	Field Coil	5	0	each
3d.	797	Gear Cover	1	9	each
2d.	685	Paper Washer for gear cover		6	doz.
2d.	681	Fixing Screw for gear cover	2	0	doz.
4d.	796	Commutator End Cover		9	each
2d.	665	Nut with Washer for dynamo end cover		9	each
6d.	666	Armature, complete with Bearings	1	10	0 each
2d.	667	Commutator End Bearing	5	6	each
2d.	668	Driving End Bearing	5	6	each
2d.	669	Washers (commutator end) 1 fibre, 2 brass	3	0	dz. sets



618

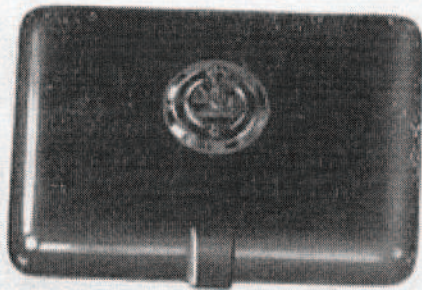

616

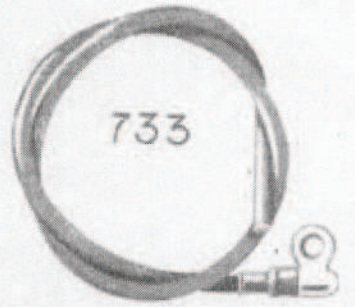

733

730

731

732



729



597



598



739



617

620



624



625



742

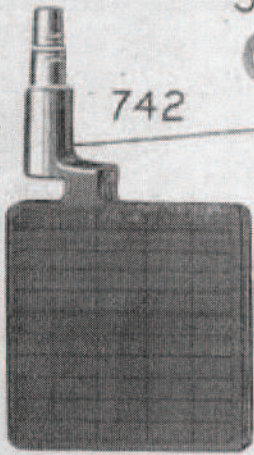

743

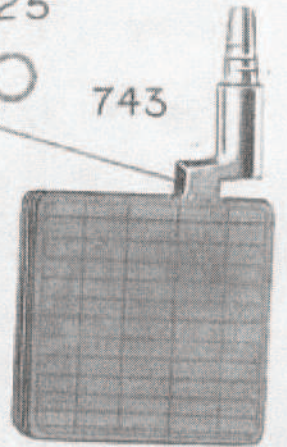

740

586

747



745

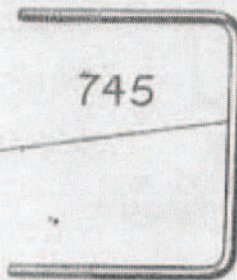

623

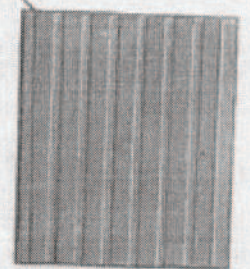

748

749

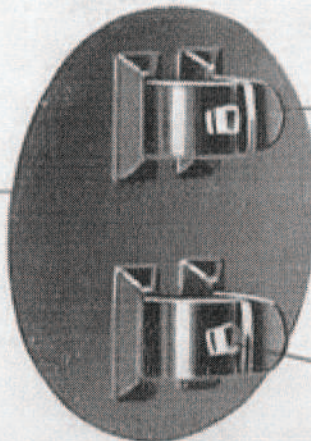
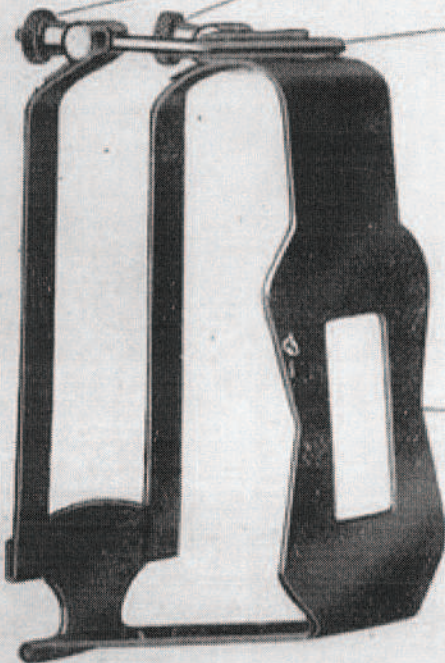

750



751



"MAGDYNO"—Dynamo Portion.

POSTAGE.	PART NO.	DESCRIPTION OF PART.	PRICE.		
			£	s.	d.
2d.	670	Washers (driving end) 1 spring, 1 brass	3	0	dz. sets
2d.	671	Collar	2	0	doz.
6d.	711	Gear Wheel, driver (61 teeth)	9	6	each
2d.	712	Gear Wheel, driven (23 teeth)	2	6	each
2d.	715	Gear Wheel, driven (steel, 23 teeth)	2	6	each
6d.	674	Gear Wheel, driver	7	6	each
2d.	675	Gear Wheel, driven	5	0	each
2d.	676	Key for gear wheel	3	0	doz.
2d.	677	Screw for gear wheels 712, 715, 675	2	0	doz.
2d.	678	Locking Washer for gear wheels 712, 715, 675	1	0	doz.
2d.	679	Lock Nut for gear wheels 711 and 674	2	0	doz.
2d.	680	Washer for gear wheels 711 and 674	1	0	doz.

"MAGDYNO"—Magneto Portion.

6d.	717	Magneto Armature, complete with Slip Ring and Bearings for two cylinder "Magdyno" (anti)	2	5	0 each
6d.	718	Magneto Armature, complete with Slip Ring and Bearings for two cylinder "Magdyno" (clock)	2	5	0 each
6d.	700	Magneto Armature, complete with Slip Ring and Ball Bearings	2	5	0 each
2d.	100	Ball Bearings for magneto armature	5	6	each
2d.	106	Packing Cup for bearings	1	0	doz.
2d.	702	Slip Ring for two cylinder "Magdyno" (anti)	6	0	each
2d.	703	Slip Ring for two cylinder "Magdyno" (clock)	6	0	each
2d.	704	Slip Ring for single cylinder "Magdyno" (anti and clock)	6	0	each
2d.	706	Oil Throw Washer	1	0	doz.
2d.	101	Washers for magneto spindle, two brass	2	0	doz.
2d.	102	Nut and Washer for magneto spindle	3	0	doz.
5d.	200	Contact Breaker, complete with Tungsten Contacts (anti)	13	0	each
5d.	201	Contact Breaker, complete with Tungsten Contacts (clock)	13	0	each
2d.	122	Contact Breaker Springs (one short and two long)			4 set
2d.	123	Long Screw, with Washer, for spring			9 doz.
2d.	124	Short Screw for spring			9 doz.
2d.	202	Rocker Arm with Tungsten Contact (anti)	2	6	each
2d.	203	Rocker Arm with Tungsten Contact (clock)	2	6	each
2d.	204	Long Screw with Tungsten Contact	1	3	each
2d.	129	Taper Fixing Pin	3	0	doz.
2d.	133	Contact Breaker Earth Carbon and Spring			6 each
2d.	135	Lock Nut with Washer for contact screw	2	0	doz.
2d.	139	Magneto Spanner			6 each
2d.	140	Contact Breaker Cover			3 each
2d.	710	Contact Breaker Cover Spring Pillar			6 each
2d.	141	Earthing Carbon with Holder			8 each
2d.	142	Carbon with Spring (earth)			6 each
2d.	143	Pick-up, complete	2	6	each
2d.	144	Carbon with Spring (pick-up)			6 each
2d.	145	Cable Securing Screw for pick-up	1	0	doz.
2d.	146	Pick-up Spring Pillar			6 each
2d.	147	Washer for pick-up	1	0	doz.
2d.	225	Timing Cage Stop Screw			9 doz.
2d.	211	Screw for spring control	1	3	doz.
2d.	212	Nipple for spring control	1	0	doz.
2d.	213	Plunger (anti) for spring control			9 each
2d.	220	Plunger (clock) for spring control			9 each

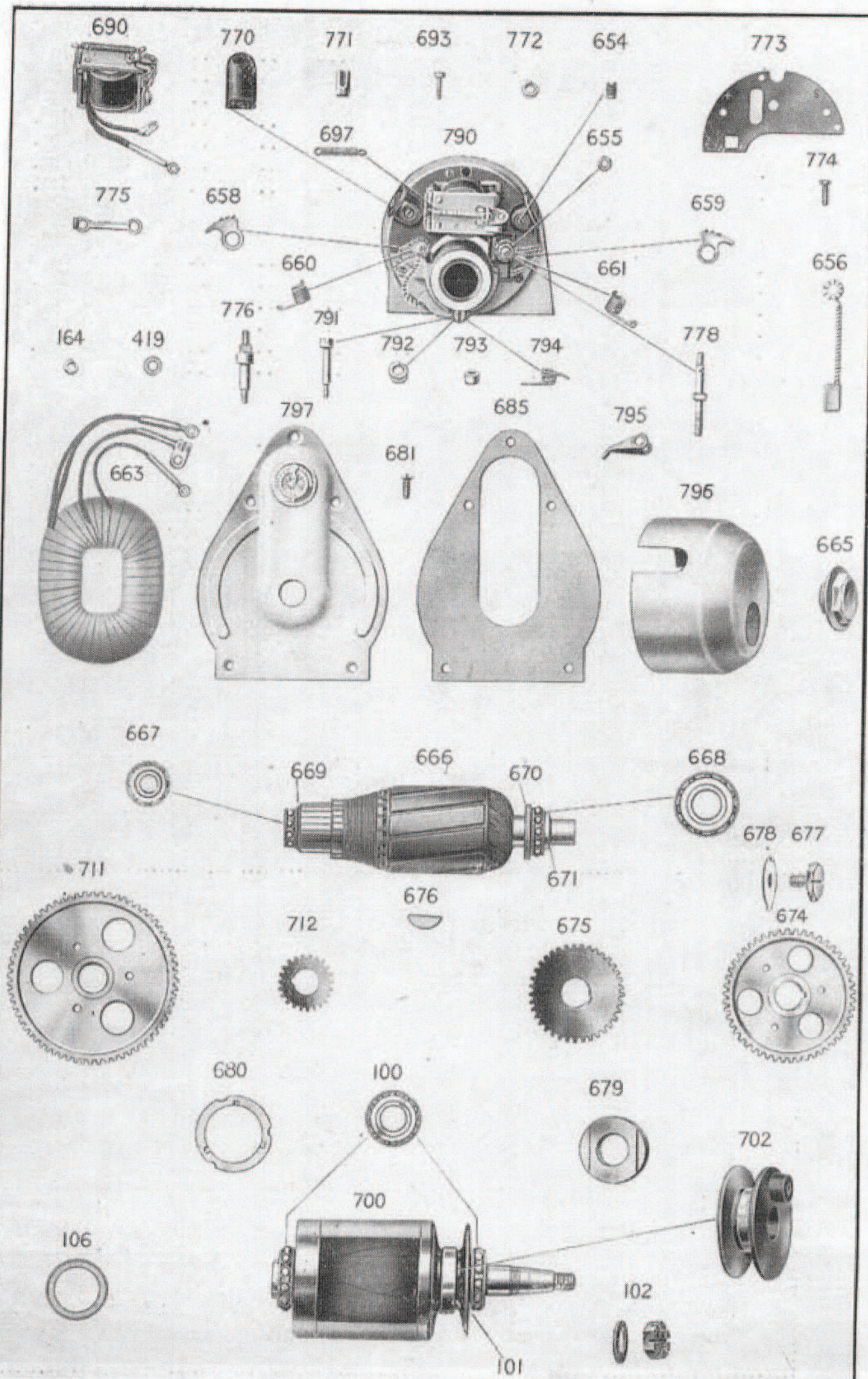

"MAGDYNO"—Magneto Portion.

POSTAGE.	PART NO.	DESCRIPTION OF PART.	PRICE.		
			£	s.	d.
2d.	223	Spring for spring control	3	0	doz.
2d.	216	Cap (anti) for spring control		9	each
2d.	221	Cap (clock) for spring control		9	each
2d.	217	Fixing Screw for spring control	1	0	doz.
2d.	218	Lock Nut for spring control		9	doz.
2d.	219	Cable Stop for spring control	3	0	doz.
2d.	222	Rubber Cap for spring control	2	0	doz.

Special Parts for "Magdynos" marked MDR and MDRB.

2d.	779	Pick-up, complete with Brushes	5	6	each
2d.	1066	Cable Screw for 779	1	6	doz.
2d.	780	Spring Pillar for pick-up		6	each
2d.	1055	Contact Breaker Cover	1	6	each
2d.	1056	Cork Ring for 1055	1	0	doz.
2d.	781	Slip Ring	6	0	each

SUNDRIES.

2d.	720	T. piece, complete		6	each
2d.	721	Washer		6	doz.
2d.	722	Wood Screw		6	doz.
2d.	723	Insulating Piece		3	doz.
2d.	725	Two Pin Plug	1	3	each
2d.	726	Socket for two pin plug	1	3	each
3d.		H.T. Cable, 7 mm.		9	yard
3d.		L.T. Cable, 5 mm.		6	yard
9d.		No. 12C Bulb Case, complete with Spring Clip and one Head Lamp Bulb and four small Bulbs (side-car or tail)	15	0	each
6d.		No. 12 Bulb Case only	4	6	each
3d.		Spring Clip for bulb case	1	0	each
2d.		Cable Clips	2	0	doz.

When ordering "Magdyno" spare parts, state type and number as engraved on the base of "Magdyno."

**CORRECT BULBS MEAN
BETTER LIGHTING!**

WHEN REPLACEMENT BULBS ARE NEEDED

**FIT LUCAS
OFFICIAL BULBS**

TO GET THE BEST POSSIBLE RESULTS
WITH YOUR LUCAS LAMPS.

Lucas Official Bulbs, before leaving our Works, have to pass definite tests to ensure accurate focussing in any of our lamps.

200

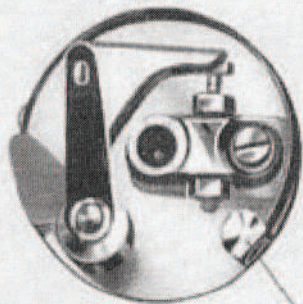

124

123



140

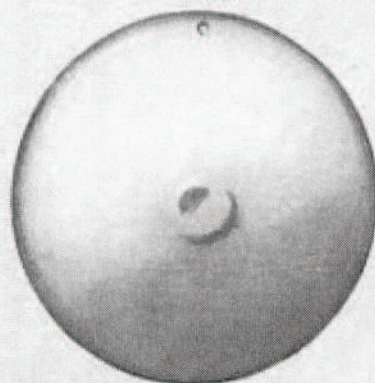

122



202

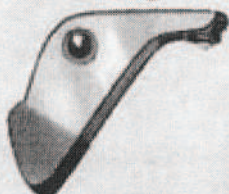

133



129



204



135



143



710

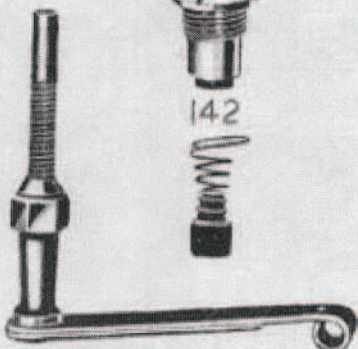

141



139



147

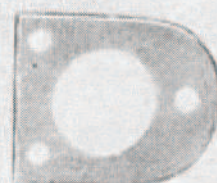

146



225



144



145



211



212



213



223

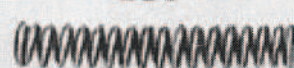

216



217



218



219

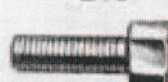

222



720



722



725

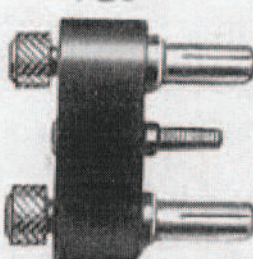

726

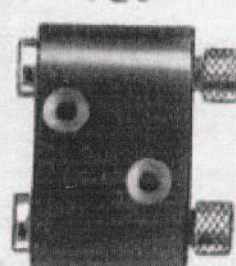

721



723



LUCAS

SERVICE DEPOTS

In the event of any difficulty with any part of the equipment, no matter how trivial, we shall be only too pleased to give every assistance possible. The best course to adopt is to call at the nearest Lucas Service Depot, the addresses of which are given below, when the equipment can be examined as a whole. The depots are not only at your disposal for repairs, overhauls and adjustments, but to give free advice. If it is necessary, however, to communicate, or when ordering spare parts, always give the type and number of the unit in question, the make and, if possible, the date of the Motor-Cycle on which it is fitted.

BELFAST	3/5, Calvin Street, Mountpottinger
Telephone: BELFAST 7017	Telegrams: "SERVDEP, BELFAST"
BIRMINGHAM	Great Hampton Street
Telephone: CENTRAL 8401 (10 lines)	Telegrams: "LUCAS, BIRMINGHAM"
BRISTOL	345, Bath Road
Telephone: BRISTOL 8400 (4 lines)	Telegrams: "KINGLY, BRISTOL"
CARDIFF	Penarth Road
Telephone: CARDIFF 4603 (4 lines)	Telegrams: "LUCAS, CARDIFF"
COVENTRY	Priory Street
Telephone: COVENTRY 3068 & 3841	Telegrams: "LUCAS, COVENTRY"
DUBLIN	41, Middle Abbey Street
Telephone: DUBLIN 653	Telegrams: "AUTOLITE, DUBLIN"
GLASGOW	227/229, St. George's Road
Telephone: DOUGLAS 3075 (3 lines)	Telegrams: "LUCAS, GLASGOW"
LEEDS	64, Roseville Road
Telephone: LEEDS 28591 (5 lines)	Telegrams: "LUSERDEP, LEEDS"
LONDON	Dordrecht Road, Acton Vale, W.3
Telephone: CHISWICK 3801 (18 lines)	Telegrams: "DYNOMAGNA, ACT, LONDON"
LONDON	759, High Road, Leyton, E.10
Telephone: WALTHAMSTOW 2161 (3 lines)	Telegrams: "LUSERDEP, WALT, LONDON"
LONDON	155, Merton Road, Wandsworth, S.W.18
Telephone: PUTNEY 5131 (4 lines) & 5501	Telegrams: "LUSERV, WANDS, LONDON"
MANCHESTER	Talbot Road, Stretford
Telephone: TRAFFORD PARK 1410 (3 lines)	Telegrams: "LUCAS, STRETFORD"
NEWCASTLE-ON-TYNE	64/66, St. Mary's Place
Telephone: CENTRAL 3571 (3 lines)	Telegrams: "MOTOLITE, NEWCASTLE-ON-TYNE"